

Reengineering the Curriculum: Design and Analysis of a New Undergraduate Electrical and Computer Engineering Degree at Carnegie Mellon University

STEPHEN W. DIRECTOR, FELLOW, IEEE, PRADEEP K. KHOSLA, FELLOW, IEEE,
RONALD A. ROHRER, FELLOW, IEEE, AND ROB A. RUTENBAR, SENIOR MEMBER, IEEE

Invited Paper

In the Fall of 1991, after approximately two years of development, the department of Electrical and Computer Engineering (ECE) at Carnegie Mellon University (CMU) implemented a new curriculum that differed radically from its predecessor. Key features of this curriculum include: Engineering in the Freshman year, a small core of required classes, area requirements in place of most specific course requirements, mandated breadth, depth, design, and coverage across ECE technical areas, a relatively large fraction of free electives, and a single integrated Bachelor of Science degree in Electrical and Computer Engineering. In this paper we review the design of this curriculum, including a taxonomy of problems we needed to address, and a set of general principles we evolved to address them. The new curriculum is described in detail, including new data from an ongoing analysis of its impact on students' curricula choices.

I. INTRODUCTION

Current engineering practice has, by necessity, evolved to keep pace with technology: witness the rate at which fundamentally new ideas are introduced into new products. One might suppose, then, that current engineering education has also evolved to track such new developments. However, we argue that engineering education has really evolved only to the extent that individual engineering courses have been updated—usually with increased density of content—to reflect new developments. The prevailing philosophy of engineering education—teach first the basics in mathematics and science, follow with exposition of engineering applications—has remained unchanged and unchallenged for more than four decades. While contributing to the creation of engineers who are current in specific technologies,

we believe that teaching of unmotivated math and science followed by incrementally updated technical courses is fundamentally flawed. It contributes little to the education of engineers who can acquire new knowledge as necessary, cope with dynamically changing work environments, or excel in nontraditional jobs. We believe that real impact in engineering education will be made only by looking at the curriculum *as a whole*, in the context of present technological and societal needs, and not just by constant repolishing of aging courses. It is not our intention to imply that engineering education has completely failed in its goals. Rather, we wish to drive home the point that there are advantages to be found in taking a fresh, *unfettered* look at the undergraduate curriculum.

Of course, curricula have tremendous inertia, and often resist all but the most incremental and cosmetic of changes. Unfortunately, many of the problems faced by engineering educators are not amenable to simple, incremental fixes. In October 1989, the college of engineering at Carnegie Mellon University (CMU) instituted a review process across all engineering departments. The goal was to evaluate how well the educational mission of the college was being conducted, with an eye toward redefining both collegewide and department-specific curriculum requirements. Because of the breadth of this undertaking, each engineering department was allowed to consider the best possible curriculum changes, not merely those that could be wedged conveniently into its current web of requirements, prerequisites, constraints, and customs. This paper describes the design and implementation of the new Electrical and Computer Engineering Bachelor's degree program that emerged from this process. This curriculum, which took approximately two years to design fully, was implemented within the de-

Manuscript received December 7, 1994; revised April 12, 1995.
The authors are with the College of Engineering, Carnegie Mellon University, Pittsburgh, PA 15213 USA.
IEEE Log Number 9413199.

0018-9219/95\$04.00 © 1995 IEEE

partment of Electrical and Computer Engineering (ECE) in the Fall of 1991, and produced its first four-year graduates in the Spring of 1995.

Within ECE, the curriculum was designed by a committee whose quickly adopted name reflected the spirit of process: the *Wipe-the-Slate-Clean Committee*. Composed of eleven faculty from across the breadth of the department's research and teaching areas, the committee interviewed both students and faculty, and worked aggressively for roughly one year to dissect, analyze, disassemble, and finally redefine the ECE undergraduate curriculum. The new curriculum that resulted from this process hinges on a few key ideas:

- Engineering courses begin in the Freshman year, concurrent with mathematics and science.
- The core of required "essential" engineering classes is extremely small.
- Area requirements across a spectrum of electrical and computer engineering topical areas replace most specific course requirements.
- Breadth, depth, and coverage are mandated across this spectrum of technical areas, but individual courses are not prescribed; students flexibly choose from among available topical areas.
- Nearly a full year of the curriculum is unconstrained.
- At completion, the curriculum offers a single, unified Bachelor's degree in Electrical and Computer Engineering.

The end result of our exercise is a curriculum which has been recently reviewed by ABET for accreditation under the ABET "innovative curriculum" clause that permits thoughtful experimental curricula that diverge from existing ABET standards to be considered on their merits. While the final outcome of the accreditation process will not be known until late 1995, comments made by the visiting team were favorable. Also, initial analysis of the three groups of freshman entering ECE in 1991, 1992, and 1993 (about 150 students in each group) indicates that the students are enthusiastic about starting engineering classes in the Freshman year and that these are helpful to the student when selecting their major. There is also evidence to show that the flexibility in the choice of electives has not resulted in a mass exodus to "easier" courses. In general students continue to elect challenging courses to suit their interests.

In this paper we share some of the details of the design process for this new curriculum, and an analysis (ongoing) of its implementation and impact.¹ Of course, we were not alone among universities as we embarked on our reengineering efforts; for example, Drexel, Rose-Hulman, and Texas A&M were already restructuring their curricula as we began our efforts, and as well the US National Science Foundation was organizing Engineering Education Coalitions with similar intent. Nevertheless, we did not join any of these efforts for fear of diluting our own efforts. So rather than attempt a broad survey of competing

¹ See [1] for a more detailed, contemporaneous account of this process, and [2] for a more recent review.

curriculum strategies, we focus entirely and closely on our own redesign effort, from beginning to end. We offer this as one case study for how one department reengineered its curriculum.

The remainder of the paper is organized as follows. Section II begins by summarizing our motivations for undertaking this effort. Section III offers a taxonomy of the basic problems faced by any electrical or computer engineering department as it struggles to keep pace with technology, students, and society. Section IV describes the design principles for the new Carnegie Mellon ECE curriculum that we evolved in response to these problems. Section V describes the details of the new curriculum, and some of its novel characteristics. Section VI describes its implementation, and recent efforts to analyze its impact on students. Finally, Section VII offers some concluding remarks.

II. MOTIVATIONS

A. Why Change?

By any traditional measure in 1991, the ECE department was doing well educating its students. The department as a whole was consistently ranked among the country's top EE departments [3] (Components of the graduate program were likewise being ranked highly [4]). The department attracted outstanding undergraduate students: ECE was the first choice among engineering departments of most entering Freshman. Our graduates were recruited heavily by US companies, and the ECE department was on the list of must-visit departments for many companies that recruited only among a select set of elite schools. Our graduates who chose to pursue an advanced degree went on to elite graduate schools.

So, why did we undertake a substantial reorganization of our curriculum? The answers are not simple, nor are they independent. We categorize our broad concerns in the following subsections, beginning with a quick overview of the original ECE curriculum as it stood in the 1990-1991 academic year. These concerns can be regarded as the beginnings of a set of "specifications" for a new curriculum.

B. Original CMU ECE Curriculum

In 1991, the ECE department offered two four-year ABET-accredited Bachelor of Science degrees: the Bachelor of Science in Electrical Engineering (BSEE) and the Bachelor of Science in Computer Engineering (BSCE). Both curricula shared a common Freshman year emphasizing mathematics, science, and computer programming. They also shared a common core of engineering classes, emphasizing linear circuits, electronics, solid state devices, digital logic design, and microprocessors. In addition, these curricula (as did all curricula in the colleges of engineering and science) shared common requirements for humanities and social science courses (called H&SS) that amounted to roughly one such course per semester. An overview of the curricula appears in Table 1.

Table 1 Original Carnegie Mellon EE and CE Curricula

Electrical Engineering	Courses	Computer Engineering	Courses
Mathematics & Sciences		Mathematics & Sciences	
Calculus	2	Calculus	2
Differential Equations	1	Differential Equations	1
Linear Algebra	1	Linear Algebra	1
Probability	1	Probability	1
Physics	3	Modern Math	1
Chemistry	1	Physics	3
Computer Programming	1	Chemistry	1
		Computer Programming	1
Electrical & Computer Engineering		Electrical & Computer Engineering	
Intro Digital Systems	1	Intro Digital Systems	1
Linear Circuits	1	Linear Circuits	1
Intro Electronic Devices	1	Intro Electronic Devices	1
Electromagnetics	2	Computer Architecture	1
Signals & Systems	2	Concurrency & Real Time Systems	1
Analog Circuits	1	Digital Integrated Circuits	1
Digital Integrated Circuits	1	Logic & Processor Design	2
EE Elective	1	Computer Science	
Senior Design Elective	1	Fundamentals of CS	2
		CS Elective	1
Electives		Electives	
Freshman	2	Freshman	2
Engineering Science	2	Engineering Science	2
Technical	5	Technical	5
Free	1	Free	1
Humanities & Social Sciences	8	Humanities & Social Sciences	8

After this common core, the two curricula diverged. The BSEE emphasized traditional electrical engineering topics such as electromagnetics, analog circuits, and signals and systems. The BSCE emphasized computer hardware and software topics such as computer architecture, processor design, data structures, and concurrency. Both curricula required several technical electives, and a capstone design elective.

In 1991, about 40% of our students pursued the BSEE, and about 50% pursued the BSCE. Roughly 10% of our students chose to double major in both electrical engineering (EE) and computer engineering (CE). This was accomplished at the sacrifice of most elective classes: Students completed the core requirements of one curriculum using the elective slots provided in the other. Also, a few of our students double-majored in computer engineering and computer science (which is in a separate college at Carnegie Mellon). This essentially required that all elective classes in the BSCE curriculum were chosen to complete computer science core requirements.

C. Remove Structural Impediments to Accommodate Incremental Change

Curricula usually evolve by accretion, with new requirements and constraints often layered incompatibly on top of existing structures. The resulting rigid course sequences connected by spaghetti-like chains of prerequisites are difficult to modify. This was certainly true of our original EE and CE curricula, and by extension, likely true in many similar Electrical Engineering departments that evolved over the last two decades to become departments of Electrical and Computer Engineering, or departments

of Electrical Engineering and Computer Science. In our own case, the end result was that even incremental changes became difficult to implement.

In the original parallel BSEE and BSCE curricula, even modest changes rippled in undesirable ways throughout the two programs. An example makes this concrete. As a result of an ABET accreditation visit, we were asked to add a linear algebra class as a graduation requirement. We responded enthusiastically, on the assumption that we could migrate the course into the early years of the curriculum, and thus make it a prerequisite for our linear circuits class. In this position, it would strengthen the background of all EE students in our circuits and electronics courses, and broaden the background of our CE students by exposing them to more noncalculus mathematics.

Unfortunately, this ideal proved impossible to implement. There was no small-scale alteration of the BSEE and BSCE course sequences that could permit the linear algebra class to be taken by all students before the courses that would use it as a prerequisite. This problem derived from the slight differences in the first few years of the BSEE and BSCE requirements. The BSCE student began to take computer science classes fairly early, so that Junior and Senior computer engineering courses were correctly synchronized with their computer science prerequisites. In contrast, the BSEE student had no such requirements. The end result was that we required our students to take a linear algebra class, but we did essentially nothing to exploit this background in other ECE core classes. This simple example makes clear how difficult it can become to achieve the goal of *uniform* mathematics, science, and engineering core preparation for both BSEE and BSCE students.

D. Rationalize Requirements for Topical Coverage and Workload

As has become amply clear over the last decade, the disciplines of electrical and computer engineering are expanding rapidly as new technical discoveries are made and applied. Likewise, society is placing increasing demands on our graduates to apply their skills in new contexts, and to appreciate and manage intelligently the consequences of their technical decisions. Consequently, the number of “critical” topics to which ECE students could profitably be exposed is also expanding. What is not expanding is the time we have to educate someone to level of the Bachelor’s degree.² Coming to grips with this accelerating problem was at the heart of our motivation for a significant restructuring of our curriculum.

The original ECE curriculum required a large number of core classes, designed to ensure familiarity with a substantial subset of traditional EE and CE topics. After a great deal of argument and discussion, we came to believe that this approach, which implicitly assumes all students need exposure to (almost) all areas, was no longer credible as the core of a curriculum for the 21st century. Such a strategy mandates that we compress ever more material into the same number of classes. Many of our courses had already fallen victim to “units-creep,” i.e., challenging classes meant to require 12 hours of work per week had inflated to require 15 or 18 hours of work from even the best of students. This was caused by well meaning faculty working hard to give students the best, most thorough view of as many topical areas they could—usually with the assumption that this was the only opportunity students would ever have to see the material.

While certainly not opposed to demanding classes, we concluded that the overall strategy of putting more material into the curriculum had become decreasingly effective. Students were being asked to absorb increasing amounts of material, which left less time for reflection, for alternative perspectives on similar technical problems, and for revisiting background material to ensure comprehension. The unpredictable preparation of entering students only exacerbated this problem: we kept discovering that many of our students had never seen material fundamental to the background of our core courses. The end result was that by forcing students to juggle too many topics with too little time to master these topics, many students were learning even less material, less well.

E. Emphasize Engineering Ideas Over Techniques

A related consequence of the explosion of material was that many students came to view their courses as a set of unrelated hurdles to be overcome. As a result, many students were acquiring only a bag of seemingly unre-

²An alternative is, of course, to extend the amount of time required to educate students to some minimum level of professional competence. Such an approach was advanced by the Massachusetts Institute of Technology in [5] which proposed a five-year accredited Master’s program as the principal mechanism for educating entry-level engineers. We return to this idea in Section VI.

lated problems and solution techniques, without ever really understanding the big ideas that bind and inform these techniques.

Conventional wisdom suggested that after first teaching a vast body of fundamental mathematics and science—which students absorbed like sponges—we were free to teach engineering principles, drawing as necessary on the deep well of basic knowledge internalized by the student in these early studies. This was (and is) a lovely idea, but depressingly unrealistic. Students often had weak or wildly varying preparation in K–12 mathematics and science, and hence uncertain motivation to master the rigorous college level versions of these fundamentals. When a flood of engineering ideas was introduced on top of this precarious foundation, the outcome was often less than satisfactory. Too often, students only had time to focus on the mechanical problem-formula-solution aspects of the topics, without developing a deeper sense of the fundamentals, the interconnections, and the real ideas.

This is especially unfortunate in a fast-moving discipline, where the half-life of a Bachelor’s degree is probably less than a decade, and a solid understanding of the “big picture” is the most successful base from which to acquire new skills. As educators, we do our students a disservice if we fail to impart a coherent, connected view of the ideas that define our discipline.

F. Support Interdisciplinary Studies

The most creative and far-reaching contributions are often made by individuals at the boundaries of several disciplines. Likewise, society is placing increasing value on engineers who can apply their skills across disciplines, and can evaluate intelligently the broader consequences of their actions. ECE is an extremely wide field, and many of its most exciting frontiers—very large scale integrated circuits (VLSI), microelectromechanical systems (MEMS), electronic materials, computer-aided manufacturing, telecommunications networks, supercomputing—have strong and established interdisciplinary linkages. However, our original curriculum did little to encourage the creation of engineers who could work comfortably across the boundaries of several disciplines.

The original curriculum implicitly assumed that there were only two sorts of engineers: EE’s and CE’s. These were produced by completion of a large, rigid core of EE or CE engineering classes. Although industry specifically, and society generally might have valued highly a student who had completed, say, 60% of the EE core classes and 40% of the CE core classes, we had no mechanism for giving this broad individual a degree. Nor did we have any mechanism for coping with an even broader individual who might have wished to complete, say, 30% of the EE core, 30% of the CE core, then a dozen classes in mechanical engineering, operations research and Japanese language, in preparation for a career in computer-aided manufacturing. Indeed, a key conclusion of the early discussion of the Wipe-the-

Slate-Clean committee was that we would like not only to tolerate such individuals, but to encourage them.

III. CURRICULUM DESIGN: PROBLEMS

A central tenet of any engineering education is that no elegant solution is likely to be found for a problem that lacks a crisp definition. Unfortunately, curricula are complex, often unwieldy creations subject to conflicting demands from the university, from faculty, from students and their parents, and from the industries that employ graduates. Nevertheless, over the course of its deliberations, our committee kept returning to several specific problems which crystallized as the basic issues to address. We summarize these here.

A. Student Preparation is Incomplete

American K–12 education can be blamed for the incomplete mathematics and science preparation of many of our students. Nevertheless, allocating blame does nothing to improve the preparation of our students after they arrive. Moreover, entering students are simply different than they were in past decades: less homogeneous, more diverse in their personal goals and career aspirations. Any curriculum redesign must deal with the following facts:

- Students have less facility and depth in the technical areas we expect all students to have seen, for example, algebra and geometry. Some unremarkable mathematical manipulations that appear frequently in introductory science and engineering classes severely tax many students.
- Students—even the best students—have seemingly random gaps in their backgrounds. In the course of our meetings, the Wipe-the-Slate-Clean Committee talked to a superb Senior EE student, a straight-A student who was being aggressively pursued by elite graduate schools. Yet she mentioned to us that she was very uncomfortable in her first circuits class, *having never seen a complex variable before*.
- Most students have almost no basic laboratory skills when they enter the department, for example: how to keep a lab notebook; how to observe an experiment; how to deal with significant digits and experimental error; how to use orders of magnitude and quick-and-dirty calculations to estimate whether a measured result is in the right ballpark or has gone badly awry, etc.
- A related point: students have virtually no hardware tinkering skills. Previous generations of EE's were notorious tinkerers, with radios and motors and the like. Upon entering college, they knew what a wire was, and a battery. They knew how to solder and read the resistor color code. This is no longer true, and the most elementary of hardware skills—what a wire is, what it does, how it can and cannot connect to a battery—must now be taught explicitly. (This is not exactly surprising, given the inaccessibility of the insides of most electronic products these days.) Our students are now much more likely to have software tinkering

experience. However, many students, especially those from less well off high schools, arrive without any exposure to programming ideas or hardware concepts.

- Student expectations and faculty expectations often differ. Roughly speaking, we tend to assume students have the background, energy and motivation to go acquire whatever mathematics, science, lab skills, etc., that they lack, if we send them off in the right direction. (This has always been true of the best students.) In contrast, many students tend to assume that we will teach them *every* topic—the big ideas as well as the basic mechanical skills, the central topics as well as the peripheral background material—without independent initiative on their part.

Any solution here must reconsider how and where in the curriculum to teach these fundamentals, and to what level of detail.

B. Student Perspective on EE, CE, and Subdisciplines is Lacking

By the time they are Seniors, faculty usually expect students to make intelligent choices when they have the opportunity to choose an engineering elective course. Students are expected to ask their faculty advisers for guidance here, and to listen to whatever advice is offered. Our experience as educators suggests that it is already questionable whether this works for Seniors, who have a fairly extensive technical background. However, it is clear that students taking their very first course in a core ECE area like solid state devices or computer architecture are usually not clear about how this area connects to the rest of ECE as a whole.

This was a particular problem in our original 1991 curriculum. At this time, ECE offered two parallel curricula: the BSEE and BSCE tracks, one of which students had to choose sometime during the Sophomore year. The problem was how to educate students to make an informed choice. Certainly, some students arrived absolutely decided on one track or the other. But many relied on our introductory courses to paint a sufficiently broad picture of the discipline for them to make a choice. Unfortunately, these introductory courses concentrated almost entirely on packing in as much engineering material as possible. As faculty, we were often surprised when, after a few weeks in class, in the middle of some intricate technical discussion, a brave Sophomore would ask something like this:

Exactly what does a computer engineer do? And how does this material help me to be a computer engineer? Is this different from computer science? Is the difference that *we* do hardware and *they* do software? When I graduate will I only be able to design big computers, or do computer engineers do something else as well? And why am I taking all these circuits classes—isn't that for the electrical engineers?

The emphasis on maximizing technical content in those few hours per week left little time to address all these questions satisfactorily. And as the breadth of the discipline continues

to expand, we must confront this problem directly if our students are to make informed curriculum choices.

C. *Appreciation of Underlying Ideas is Weak*

We are not alone in observing that students often acquire only the mechanical aspects of the topics that we teach, without understanding the underlying ideas. The problem is pervasive in the teaching of technical material. For example, a National Science Foundation article on the teaching of college calculus relates this story [6]:

A mechanical engineering professor mentioned in passing to a class of sophomores that an integral is a sum. He simply assumed that the students had learned this basic idea from first-year calculus. But the students stared uncomprehendingly back at the professor. "Students seem to have a facility for doing things," [the professor] concludes, "but they lack a sense of ideas."

Similar stories were easy to come by in our own department. For example, in [7], one of our own faculty observed:

[In several ECE courses] I've worked hard to help students achieve a rich and insightful understanding of fundamental material. Most of them seem to think I do a good job; they say on their FCE's [Faculty Course Evaluations, a survey of each student's evaluation of and reactions to the course, conducted by Carnegie Mellon itself] that I make even difficult and abstract concepts seem clear.

Yet, when I look at the reality of their understanding, as gauged through exams and discussions in and out of class, it's grossly disappointing. The majority simply *don't get it*. Their survival skills allow many to get through with C's and D's, based mostly upon regurgitation of techniques I've shown them repetitively, as both they and I have forced ourselves through a distasteful process of pounding in material which they find mysterious and useless and which I find beautiful and important.

Students' varying technical preparation, the increasing diversity of their backgrounds, the divergence of student and faculty expectations and the widespread practice of packing ever more material into the same number of classes all compound the problem. We argue that curriculum designers must now address this problem directly. The mere mechanical skills that a student acquires in "survival" mode have a disturbingly short half-life in our rapidly moving discipline. The question is how to motivate students to appreciate the connectedness among abstract ideas, concrete applications, their classes, and their careers.

D. *Breadth in All Relevant Topical Areas is Impossible*

A foundation of many "classical" engineering curricula is the notion that every engineer must know something about every area of the discipline. There was certainly an era in which this was a reasonable assumption for electrical engineers. We argue that this is no longer a viable assumption—especially for an ECE department whose

faculty engage in a broad program of research ranging from basic physics to advanced computer science. Distancing a curriculum from this notion is difficult, since it tramples on nearly every faculty member's most cherished subjects. Any attempt to reach consensus on a minimum set of advanced topics to mandate in a curriculum rapidly yields a huge and unwieldy set of essential classes.

One approach that we had already tried in 1991 was to partition the undergraduates into separate degree tracks leading to different BS degrees. As Carnegie Mellon's EE department evolved into an ECE department, its degree offerings evolved into parallel BSEE and BSCE tracks. Computer engineering faculty argued that many required electrical engineering classes were inessential to the education of a computer engineer, and should be replaced by more relevant course requirements. Electrical engineering faculty countered that if students did not take the full complement of required electrical engineering classes, they should not be graduated as "electrical engineers." So, a separate computer engineering degree was an agreeable solution.

In hindsight, this debate nicely crystallizes a key problem for curricula as they try to evolve: what is *essential* to earn a degree with the words "electrical engineer" (or, in our case "computer engineer") in the title? Slicing off portions of the curriculum to award them separate degrees whenever they attain some sort of "critical mass" is not a viable long-term strategy: New technologies and ideas become candidates for core topics in the curriculum faster than old topics expire. Any serious attempt at curriculum redesign must address the necessarily contentious issue of which topics are truly essential.

E. *Interdisciplinary Studies are Difficult*

Many engineering curricula are based on a large number of required engineering classes and restricted technical electives. This was certainly true of our original ECE curriculum. The problem was how to deal with a student who wished to trade some technical depth for breadth. In 1991, one of our BSEE students could take some computer engineering courses, just as a BSCE student could take some electrical engineering courses. But we had no mechanism to give a degree to someone who chose to be broad, who chose to take, for example, 50% of the required electrical engineering core courses, and 50% of the required computer engineering courses. Some of our best students solved this problem by double majoring in both EE and CE. But this required completing 100% of both curricula, using elective slots in one track to take required core courses from the other track. This challenging but rigid program ended up being a four-year degree with essentially no elective classes.

More generally, we argue that there is a need for mechanisms to allow for students to trade engineering depth for breadth—either breadth within a single department (electrical engineering *and* computer engineering), or breadth

among other disciplines (for example, electrical and mechanical engineering).

F. Demographics Have Changed

In 1991 it was already clear that, on the entering side of the curriculum, our students were less homogeneous than in the past. Today, any department serious about attracting and retaining talented but underrepresented minorities to engineering must expect further diversity in their backgrounds. The problem of students not having the basic skills and motivations we would prefer of them may yet worsen. Thus we argue that it is appropriate simply to construct the first few years of courses around this fact.

On the graduating side, there is also increasing diversity. As faculty members, it is common for us to treat our students as though they are replicas of ourselves, i.e., to assume they all wish to become first-class researchers and stay on a technical path for the rest of their lives. But such students are clearly in a minority. Many of our students who graduate to become engineers will not stay in technical positions for their whole lives. Moreover, it has become increasingly apparent in recent years that a few of our best and brightest do not choose an engineering degree with the intent to become practicing engineers, but rather with the intent to enter other postgraduate professional schools, such as law, business, and medicine. To encourage a population of more broadly educated engineers, we must refuse any urge to relegate these particular students to second-class status, or deride them as defectors from the fold. Indeed, we can see few negatives associated with the idea of a future generation of technically literate legislators, judges, physicians, and business leaders.

The central question is how to structure a curriculum to handle the educational needs of all these constituencies: the committed technologist, the mainstream engineer who may be in management in less than decade, and the interdisciplinary student using ECE as a launching point for a career in an another professional discipline. In our own curriculum redesign, we concluded that these facts argue for a curriculum in which a strong core of ECE topics can be augmented with advanced ECE classes, or preparatory courses for other disciplines.

G. Rigid Curricula Impede Necessary Changes

As mentioned in Section II-C, many curricula evolve by accretion, and the resulting web of constraints can render even modest changes difficult. Hence, we suggest that another problem to address directly is *planned growth*: how to structure the curriculum to add flexibility to its basic organization so that necessary incremental changes are more easily effected.

IV. CURRICULUM DESIGN: SOLUTIONS

Before describing the exact organization of the new ECE curriculum created in response to the problems raised in the previous section, we summarize our attempt at general solutions to these problems. The ideas described here can

be regarded as the “design principles” for our revised curriculum.

A. Teach Engineering Early, Concurrent With Fundamentals

In our original curriculum, the Freshman year was common to all departments in Carnegie Mellon’s college of engineering, and emphasized mathematics, science, and humanities. A few “Freshman elective” slots were available, as well as a few so-called “Engineering Science” slots (comprising elementary statics, dynamics, thermodynamics, material science, and so forth; see again Table 1), but the choices comprised an *ad hoc* selection of peripheral engineering courses largely unrelated to the core curriculum of any engineering department. Students were mostly disappointed by these courses.

In the new curriculum, every department in Carnegie Mellon’s college of engineering offers a Freshman engineering course that introduces students to the ideas, problems, modes of thought, tools and techniques of its discipline. Every student takes at least two such courses in their Freshman year, concurrent with their mathematics, science and humanities classes. ECE offers a single course, called *Introduction to Electrical and Computer Engineering*, that strives specifically to provide an integrated view of connectedness of the EE and CE problems.

The unifying idea here is to expose students to real engineering as early as possible, to motivate their studies in necessary mathematics and science courses while they are taking them, and to teach explicitly some manual skills they mostly lack. The goal is to generate real enthusiasm—the “Aha!” that accompanies insight as students grasp that they can, for example, model interesting physical phenomena with a little mathematics, science and judgment—and let them get their hands dirty on real problems. This experience demonstrates to new students the practical need for more preparation in subsequent mathematics and science classes, and also provides students with the elementary hands-on laboratory skills that they often lack. At the college level, it allows undecided students to sample various engineering departments to be sure they are choosing the right one.

B. Base Curriculum Requirements More on Areas, Less on Specific Courses

The original EE and CE curricula were each based on a rigid core of required classes. In the new ECE curriculum, we first drastically reduced this required core, from about a dozen courses down to a select few. Next, we replaced the bulk of the remaining specific course requirements with *area* requirements: ECE was “partitioned” into a spectrum of topical areas, and all upper-level courses assigned to one of these areas. Students are required to demonstrate breadth, depth and coverage across some chosen subset of these areas. However, we no longer require students to take one or two courses in *every* core EE or CE area. Instead, we let students demonstrate that they are broad enough to take courses in several—but not all—different areas, and that they are deep enough to take more advanced courses

in some—but not all—areas. Coverage requirements—to ensure that the student takes enough ECE courses to be called an engineer—and a capstone design requirement complete the basic curriculum.

C. Increase Flexibility, Elective Courses

The original curriculum featured a hodgepodge of curriculum-specific elective slots (the BSEE and BSCE manifested different constraints on allowable electives) restricted in a variety of *ad hoc* ways. The actual number of completely unconstrained elective slots was amazingly small: one course slot.

The new curriculum substantially increased the number of unconstrained elective slots: We allowed slightly less than one full year of free electives. Aside from the fact that these courses must be ones for which students receive credit and a grade, they were not further constrained. The intent here was not to reduce the rigor, complexity, or depth of understanding associated with the ECE degree. Rather, the intent was to create new opportunities for more broadly based curricula that integrate ECE courses or courses from other disciplines in innovative ways. We saw no reason to prevent an ECE student with an interest in, say, integrated silicon sensors, from taking a half dozen courses chosen sensibly from mechanical engineering, physiology, biology, chemistry, mathematics, or physics. Nor did we see any compelling reason to prevent an ECE student with an interest in computer speech recognition from taking a year of linguistics, a foreign language, or even music theory and cello mastery. Adhering to some unnecessarily rigid concept of an ECE degree only stifles the creation of innovative programs of study, and innovative engineers themselves.

D. Manage the Workload

In the original curriculum, students typically took five courses per semester. Usually, these comprised four technical classes and one humanities class. Especially in the last two years of their studies, engineering classes tended to inflate in content past their specified units as our faculty members struggled to compress every relevant topic, technique, nuance, and anecdote into their classes. During such semesters, the nominal 40–50 hours of work per week (computed by tallying the units on each student's classes) was at best an optimistic lower bound on the time students needed to invest to survive. Independent of the merits of demanding course schedules, our students were juggling too many topics, often at unsustainable levels of stress and well beyond an optimal level for real understanding.

In the new curriculum, we first attacked this by reducing the number of courses from five per semester to four. ECE courses remained challenging and work-intensive, but the switch to one fewer class per semester made it possible for ordinary students to concentrate fully on their studies and master their material. We also tightened the requirements for “overloading,” that is, taking a course load beyond a reasonable number of units, in our case roughly 4.5

courses per semester. In the original curriculum, any student with a sufficiently high aggregate grade point average could overload. The problem this occasionally created was students who, having achieved good grade point averages on nonengineering courses in their early years, would later elect an insupportable engineering course load and perform weakly in each course. In the new curriculum, an overload requires a high grade point average for the courses in the preceding semester; now, a student must demonstrate continuously the ability to excel while taking extra courses, or those courses cannot be elected. Again, the strategy here is to encourage mastery, rather than mere survival, in a core set of carefully selected courses.

In addition, we rendered the workload a bit more uniform across all ECE courses by reallocating topics more carefully across course sequences. (In the original curriculum, topics tended to creep downwards through a course sequence, to make room for more topics at the high-end of the sequence.) Finally, we made all ECE courses the same number of units, in some cases adding laboratories to relatively abstract and mathematical courses like electromagnetics and signals and systems to balance out the per-course workload.

E. Offer One BS Degree, Not Two

In our original curriculum we offered two degrees: the BSEE and BSCE. In the new curriculum, we offer only one: the Bachelor of Science in Electrical and Computer Engineering, or BSECE. There is an appealing symmetry here. We originally offered a single BSEE degree when we were the department of Electrical Engineering. As the computer engineering discipline gained stature, we offered a BSEE “with Computer Engineering Option” which eventually split off to become the separately accredited BSCE degree. Now, we have merged all our degrees back into a single integrated BSECE. This explicitly recognizes evolutionary trends in the discipline and in industry to emphasize the commonality across EE and CE, and not the differences.

F. Structure Curriculum to Accommodate Change

In the old curriculum, the rigid set of interlocking course requirements made even small changes difficult. A key feature of the new curriculum is that it is based less on specific courses, and more on requirements to take courses in general topical areas. By organizing the curriculum to be more loosely independent of the content of specific courses, we freed it to adapt more easily to change. It now is much easier to see how to add a breadth/depth course, a new topical area, or even a core requirement. As the discipline itself evolves, the new curriculum should be able to absorb necessary incremental changes without violating the basic spirit of its design.

V. THE NEW ECE CURRICULUM

We can now describe fully the redesigned ECE curriculum as it was proposed in the Fall of 1991. We begin by surveying the basic components of the curriculum, their organization and relationships, then enumerate the specific

requirements for the new BSECE degree, then describe the key new courses in the curriculum. In the following section we will revisit this organization in light of some evolutionary changes from 1991 to 1995.

A. Basic Organization

Fig. 1 illustrates the basic components of the curriculum by topic; Fig. 2 adds detail to show how courses are allocated among these areas. The architecture of the curriculum is essentially simple, and comprises the following:

- A typical humanities and social sciences component (Eight courses).
- A typical mathematics, science and computer programming component (Seven courses).
- Freshman engineering courses—very much atypical—which use these mathematics, science, and programming classes as corequisites (At least two courses).
- ECE core requirements, a set of two fundamentals classes (in addition to a required ECE Freshman engineering course) required of all ECE students. These courses are the gateway to all elective upper-level ECE courses (Two courses).
- ECE breadth requirements, selected from across the set of specified topical areas in ECE, to ensure exposure to different styles of thinking, modeling, and problem-solving (Three courses).
- ECE coverage requirements, to ensure enough exposure to ECE courses to earn a degree called Bachelor of Science in Electrical and Computer Engineering (At least three courses.)
- As part of the coverage requirement, an ECE depth requirement to ensure that students can handle advanced as well as introductory material (One course of the three coverage courses.)
- Also as part of the coverage requirement, a capstone design requirement, to ensure exposure to the unique problems of building concrete engineering artifacts under tight time, resource, and cost constraints (One course of the three coverage courses.)
- Free electives, nearly one year in all, to be chosen by individual students based on their interests and goals (Seven courses).

B. Flexibility and Electives

The key attribute of this new curriculum architecture is its flexibility. Requirements to “take one course in every important area” or “attain basic mastery in every area,” which in the past led to cumbersome intertwined course sequences are avoided entirely. Instead, we mandate only select core knowledge, along with breadth, depth, coverage, and design. Within this framework, many sensible plans of study can be formulated, some favoring depth, some favoring breadth, others somewhere in between. Another important consequence of this flexibility is that it accommodates new students with different backgrounds and skills:

- The best students can begin engineering classes earlier, and pursue several ECE areas in great depth.

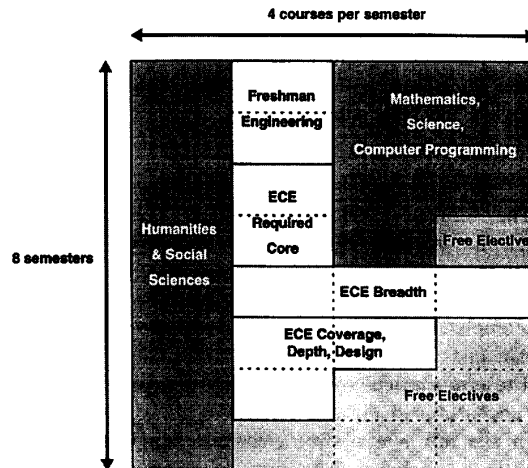

Fig. 1. New ECE curriculum: Basic organization in 1991.

- Students inclined to be generalists can, within clear limits, trade depth for breadth, and explore a wider range of ECE topical areas. At the very least, we can now actually accommodate the student who wants to take, say, half of her courses in traditional electrical engineering topics, and half in traditional computer engineering topics.
- Those with more potential than actual preparation can use electives to fill in any gaps, and defer some engineering until later; these students in particular may benefit by choosing to tradeoff some depth for breadth.
- Interdisciplinary students now have the time to dive into another discipline, its background topics, its core classes, and even a few advanced courses. This is helpful for students pursuing a parallel technical discipline, as well as students using ECE as preparation for graduate studies in another profession such as medicine, law, or business.

The large number of free electives deserves special comment. Interestingly, it seems that the presence of *any* free electives in an engineering curriculum is rare, let alone nearly a full year as the new ECE curriculum allows. The desire to pound increasing amounts of technical, discipline-specific material into our students in the same number of hours per week is at least partially to blame here. However, blame has also been attributed to the engineering accreditation process [9]:

For more than a century and a half, engineering schools in the United States have pursued a variety of educational philosophies, offering programs built around their local comparative advantages. The resulting diversity has been an important source of national technological strength. Today, faced with challenges induced by rapid global political, economic, and environmental change, we need diversity and innovation in our new engineering graduates more than ever before. . . . But, in contrast to the flexibility of undergraduate science education, heterogeneity and innovation in US engineering education

FRESHMAN	FALL	Humanities & Social Sciences	Introduction to ECE	Computer Science Intro Programming	Calculus I
	SPRING	Humanities & Social Sciences	Introduction to Engineering	Physics I	Calculus II
SOPHOMORE	FALL	Humanities & Social Sciences	Fundamentals of Electrical Eng	Physics II	Linear Algebra
	SPRING	Humanities & Social Sciences	Fundamentals of Computer Eng	Modern Math	Free Elective
JUNIOR	FALL	Humanities & Social Sciences	ECE Breadth 1	ECE Breadth 2	ECE Breadth 3
	SPRING	Humanities & Social Sciences	ECE Coverage (Ex: Depth)	ECE Coverage	Free Elective
SENIOR	FALL	Humanities & Social Sciences	ECE Coverage (Ex: Design)	Free Elective	Free Elective
	SPRING	Humanities & Social Sciences	Free Elective	Free Elective	Free Elective

Best Copy Available

Fig. 2. New ECE curriculum: Allocation of courses to areas in 1991.

are threatened by the creeping demands of our system for accrediting undergraduate engineering curricula. . . . When a school's most basic educational objectives and the Accreditation Board for Engineering and Technology (ABET) constraints have both been met, there is often little or no flexibility left. It is not unusual for an engineering undergraduate to have no opportunity to select a completely free elective course.

Whatever the reason, the pressures for limiting electives to a negligible few have been numerous and well intentioned. Nevertheless, if one of our goals is to increase the diversity among the population of Electrical and Computer Engineers that we educate—both the diversity of their background upon entry and their portfolio of skills upon graduation—a substantial number of free elective courses is a sensible solution.

C. ECE Core: Overview

The new curriculum introduces three critical new courses. By the end of the Sophomore year, the average student will complete the small ECE core, comprising these courses:

- *Introduction to Electrical and Computer Engineering*: which has introductory calculus and computer programming classes as corequisites, introduces basic engineering ideas related to electricity and computers. It is typically taken during the first year.
- *Fundamentals of Electrical Engineering*: which has a linear algebra class as a corequisite, is a course in linear circuits. It is typically taken in the second year.
- *Fundamentals of Computer Engineering*: which has a discrete math class as a corequisite, is a course in

digital design, microprocessors, and elementary computer organization. It is typically taken in the second year.

In the following sections we describe the contents of these courses in more thorough detail.

D. ECE Core: Freshman Introduction to Electrical and Computer Engineering

Although our incoming Freshmen are highly motivated, many have no real understanding of what undergraduate studies in engineering are all about, and few have the hands-on laboratory experience that was common a decade ago. In the original curriculum, our Freshmen took preparatory courses such as physics and calculus, but waited until the end of the second year to take any real engineering courses. The result was often a significant reduction in motivation as students worked to understand a wealth of relatively abstract fundamental mathematics and science presented without any supporting ECE-specific engineering context.

Our new Freshman introductory course rectifies this situation. The course motivates and introduces basic concepts in Electrical and Computer Engineering in an integrated manner, provides hands-on laboratory experience early, and strives to imbue students with some ability to look at the "big picture" and ask questions that will lead to a solution to the problem at hand. A simple mobile robot system serves as the experimental vehicle to motivate the teaching of basic concepts like Kirchhoff's laws, dc models of circuit elements, logic gates, flip flops, counters, and so forth. The subsystems that comprise the robot provide the basis for

Table 2 Syllabus for Freshman Introduction to Electrical and Computer Engineering Course

Functional Decomposition of a System

- Block diagrams

Basic Circuit Concepts

- Ideal voltage and current sources
- Real voltage and current sources
- Behavioral model of R,C elements
- KVL, KCL, Ohm's law
- Behavioral model of active devices: transistor, diode, Zener diode
- Operation of a dc motor
- Transducers: LED, touch switch, speaker, ultrasonic range sensor
- Ideal op amp model
- Inverting amplifier
- Buffer and noninverting amplifier
- RC time constants

Digital logic concepts

- Digital signals
- Binary numbers
- Logic numbers
- Karnaugh maps
- Flip flops and Shift registers
- Asynchronous logic
- Synchronous logic
- Coding (BCD)

Building Complex Systems from Basic Building Blocks

- Interconnecting digital elements
- Interconnecting circuit elements

Laboratory Project: Building a Working Robot

- Electrical safety
- Dealing with power supply and motor
- Dealing with transducers: LED's, beeper, touch switch, clock, buffers
- Dealing with digital subsystems: gates, flip flops, counters, rest
- Dealing with the system: memory, programmed, and hardwired control
- Integrating all the pieces

a sequence of interesting laboratory exercises. The basic syllabus appears in Table 2.

Since ECE is a blend of physics, mathematics, computer science and engineering practice, the course covers both theory and applications. Lectures emphasize theoretical aspects, laboratories emphasize experimental techniques, and recitations focus on problem-solving skills. The robot is used to illustrate how complex systems can be decomposed into subsystems and to motivate the need for the theory behind each of these subsystems. In the laboratory, students analyze, construct and test these subsystems to make sure they really do work as predicted by theory. The laboratory experience also demonstrates the thought processes behind the development of complex systems with many component parts. The virtues of focusing on a small robot are that it is simple enough for Freshmen to understand, complex enough to illustrate the larger view of how EE and CE ideas mesh, and provocative enough to keep students interested when the going gets tough.

The course focuses on black box models of systems, such as power supplies, sensor circuits and digital controllers, and the behavioral description of primitive elements, such as resistors, capacitors, transistors, gates, and flip flops. We begin by considering a black box model of a system and then move to consideration of black box descriptions of

each subsystem. This process is repeated until we ultimately consider primitive elements like circuit components.

For example, while considering the power supply, we introduce notions such as *voltage regulation* and *load capability*. At this time, concepts such as an *ideal source* and a *real source* are introduced, along with a behavioral model of resistive element—which of course turns out to be Ohm's law. We end up decomposing this subsystem into resistors, capacitors, transistors, batteries (or voltage sources) and Zener diodes. We develop simple models of each of these elements and introduce the relevant physical quantities (e.g., charge, current, voltage) and relationships. For example, for a capacitor, we tell students how the current flowing through the device is proportional to the slope of the curve defining the time-varying behavior of the voltage across its terminals; this can be illustrated quite clearly in graphical form. Similarly, we illustrate the behavior of an ideal diode graphically, using current versus voltage plots. This serves as a foundation for discussion of elementary transistor behavior. An understanding of each of these circuit elements allows students to grasp the overall structure of the power supply itself, and provides us with the context for introducing fundamentals like Ohm's law, Kirchhoff's voltage and current laws, and implicit techniques for circuit analysis. Note also that our behavioral models of the transistor and diode are introduced without ever introducing the concept of electrons, holes, doping, etc. These notions are really not required to understand the basic workings of a transistor or diode, and the engineering context for developing these ideas has not yet been established. This approach has been referred to by some as *just-in-time learning* [8], since we avoid piling up a potentially confusing inventory of unmotivated and mystifying theory and mathematics taught with the promise that "it'll be good for you—we'll tell you why later."

A set of coordinated laboratory exercises track the lectures and give many students their first hands-on laboratory experience. Although the ultimate aim is to assemble a working mobile robot, students attain this goal through a series of smaller projects that allow them to test the ideas being developed in lecture. For example, while a power supply is being dissected in lecture, students are building, testing and debugging a simple power supply (on a proto-board separate from the robot itself) to ensure that they understand what will actually be happening after they wire up their robot's supply. These exercises are also designed to show how systems are built and tested in a methodical manner.

Similarly, we enumerate, decompose, and describe the other subsystems of the robot, such as the motor driver, the sensors, and the digital control and programming components. Digital topics are then similarly introduced as black box behavioral models, and students acquire the fundamentals of Boolean algebra, combinational circuits, simple sequential circuits like counters, memories, and so forth. One of the important points we stress is the connection between analog and digital ideas. In our current

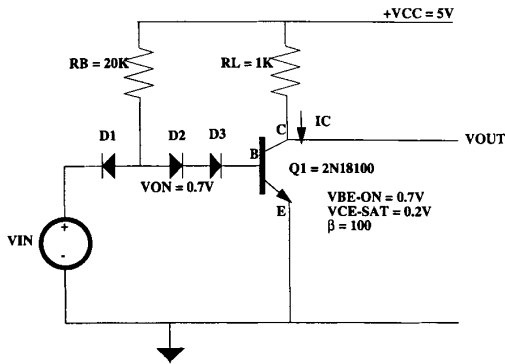

This circuit consists of a general transistor inverter that is used to interface to TTL logic. Suppose the range of logical 1 is defined to be anything between 2.5V and 5V and logical 0 is defined to be between 0V and 1.2V. Anything in between 1.2V and 2.5V is an incorrect logic value.

- Draw VOUT as a function of VIN. Mark the beginning and end of each piecewise linear region on the VIN axis. In each of these piecewise linear regions, mark the state of D1, D2, D3, and Q1. For example, write D1=off, D2=on, D3=on, Q1=forward active. Hint: It may help you to think of D2 and D3 as a single diode with $V_{ON} = 1.4V$.
- β can vary substantially during manufacturing. Determine the minimum value of β such that the logic gate still operates correctly. Hint: the limit on β will occur when $V_{IN} = 2.5V$ and $V_{OUT} = 1.2V$ so you should solve for β to make this happen.

Fig. 3. Example final examination problem from Freshman introduction to ECE.

curriculum, entering students often have no clear vision of the relationships between the EE and CE “ends” of the department. In our original curriculum, students were exposed to analog systems in the guise of circuit analysis in an introductory circuits class, and then exposed to digital systems in another introductory course on combinational and sequential logic. Accordingly, some students developed an “us” versus “them” parochialism as they came to identify themselves as primarily electrical engineers or primarily computer engineers. The new curriculum strives to remedy this by exposing our students *immediately* to a more unified view of the different disciplines comprising ECE.

Finally, it is worth noting that, properly motivated, it is possible to treat nontrivial subjects in such a course. Fig. 3 shows an example of a design problem from a recent final examination in this course. In a more traditional curriculum, one would never expect first-semester Freshmen to be solving problems such as these.

E. ECE Core: Sophomore Fundamentals of Electrical Engineering

This is the first real “circuits” course. It differs from traditional courses primarily in two ways. First, it exploits the fact that students have had some real exposure, both practical and theoretical, to linear circuit ideas and issues in the robot project from the Freshman *Introduction to ECE* course. The Freshman course is a prerequisite; a linear algebra course is a corequisite. Second, the course uses a nontraditional focus (like the robot in the Freshman course) to motivate students and provide a vehicle for developing

the fundamentals. This focus is transient analysis of linear interconnect circuitry, or, said another way: *how fast can a computer be?*

The course introduces the idea that computer system speed is measured in millions of instructions per second (MIPS)—the more MIPS the better. Students are assumed to have a rudimentary idea of what a computer instruction is from their assembly and test of the stored program control portion (memory plus state machine) of the robot in *Introduction to ECE*. We explain how, a decade or so ago, this speed was determined more by transistor size, i.e., how small a device could be made, how many could be packed inside one chip. But now and for the foreseeable future, computer system speed is determined more by the interconnect wiring itself, inside the chips, among the chips, and among the increasingly exotic system-level packages that carry the chips. This focus provides a suitably interesting context to introduce the basics of lumped linear circuits: resistance, capacitance and now, inductance.

As expected, the course focuses on studying in detail many simple RLC circuits. However, we always motivate these studies by asking the question: *what will be the effect on switching signal behavior?* The goal is to show that simple circuits provide the right insights to understand even the most complex of interconnections, and that complex circuits can be understood by mastering the basic concepts of circuit theory: Kirchhoff’s current and voltage laws; superposition and convolution; series, parallel, and ladder circuit analysis; Thevenin’s and Norton’s theorems; natural frequencies and $j\omega$; circuit partitioning; and nodal analysis [10].

The class has lectures, a laboratory session, and a recitation session. Lectures motivate and develop theoretical material, laboratories provide more hands-on exposure to circuits to test how well the theory really works, and recitations provide opportunities for problem solving and review. Table 3 shows a syllabus of topics for this course.

F. ECE Core Requirement: Sophomore Fundamentals of Computer Engineering

This course builds upon the rudimentary digital design and computer engineering concepts presented in the Freshman *Introduction to ECE* class. (The new course was actually patterned more closely on an existing course than either of the other two fundamentals classes.) The emphasis is a “vertical slice” through the layers of abstraction that comprise computer design, including: a gradual, bottom-up evolution from 0’s and 1’s up to basic processor architecture, and an integrated hardware and software laboratory that closely tracks the lectures. In the older curriculum, this course was our students’ first exposure to ECE, and their first hands-on hardware laboratory. The new course benefits from the exposure our Freshman have already had to basic digital elements and real design problems. Hence, the new course is a slightly more aggressive version of its predecessor that relies on students’ recently acquired background to revisit digital design ideas in more depth

Table 3 Syllabus for Sophomore Fundamentals of Electrical Engineering

A Brief History and Forecast of Microelectronics

- Sizes, speeds, and complexities of IC's from 1970–present, projected to the year 2000

Fundamental Electrical Concepts

- Review of voltage, current, Kirchoff's Law's and element relations for ideal independent voltage sources and resistors and capacitors

Single Time Constant RC Circuits and Constraints on Gate Delay

- DC steady state and transient solutions of circuits with DC sources, switches, and a single capacitance: exponential waveforms, their asymptotes and time constants
- Gate delay and limitations on CMOS digital circuit switching speed derived in terms of switch, resistor, capacitor models of constituent transistors of CMOS inverters

RC Ladder Circuits and On-Chip IC Interconnect Characteristics

- Distributed and lumped models of uniform RC line and for IC interconnect
- Detailed analysis of transient response in terms of one and two lump ladder circuit models of such lines. Solutions of second-order equations in coupled first-order matrix form

Switching Circuit Performance Limitations Caused by Capacitance

- Fanout effects on switching speed with and without consideration of interconnect
- Switching time speed-up strategies
- Line-to-line capacitance coupling and its effects on switching speed and crosstalk

Package Inductance and RLC Circuit Analysis

- Inductance and its differential equation
- Second order equations that arise from RLC circuits, their natural frequencies, and the general forms of their solutions. Overdamped, critically damped, underdamped, and undamped cases

Transmission Lines

- Telegrapher's equations; wave propagation down distributed LC lines; signal delay

Basic AC Circuit Analysis

- Sinusoidal steady state; superposition of independent frequency components; peak, average, RMS value calculations

Advanced AC Circuit Analysis

- Complex representation; phasors; complex impedance; the frequency domain

Nodal Analysis

- Matrix formulation of arbitrary circuit topologies; solution strategies; introduction to simulation methods

and with a greater emphasis on systematic analysis and synthesis. A syllabus appears in Table 4.

Overall, the course is designed to demystify computers for our students. It builds up the concepts that define and inform each layer of the conventional design hierarchy: combinational circuits, sequential circuits, register transfer level, stored program computing, control path/data path partition and implementation, rudimentary instruction set architecture and assembly language programming. Advances in programmable logic [11] (PAL's, field programmable gate arrays, etc.) and associated design software have made it possible for laboratory assignments to target more interesting problems; recent examples include floating point arithmetic hardware, chess move generation, and video game controllers. Use of a software-simulated processor for assembly language programming allows campus-wide electronic access, and easy alteration of the instruction set (via simulated microcode) for faculty and students. The course provides a foundation for students who wish to pursue more advanced computer engineering courses, and for those whose interests lie elsewhere in ECE.

Table 4 Syllabus for Sophomore Fundamentals of Computer Engineering

Binary Number Systems

- Positional number systems; useful radices: unsigned binary, octal, and hexadecimal
- Signed numbers: sign magnitude, ones complement and twos complement
- Floating point numbers: sign, mantissa, exponent; basic arithmetic operations

Combinational Circuit Design

- SSI logic gates
- Boolean algebra and canonical forms
- Minimization via Karnaugh maps; via cubes; via Quine-McCluskey procedure; via 2-level and multilevel computer synthesis tools
- MSI building blocks: multiplexers, decoders, ROM's and PLA's
- Arithmetic circuits

Sequential Circuit Design

- Introduction to behavior of sequential circuits
- Basic latches and flip flops, latch/FF timing and triggering
- Sequential (state machine) design methods
- Computer synthesis and optimization tools for sequential circuits
- MSI sequential parts: registers, shift registers, counters

Rapid Prototyping Technology

- Field programmable gate array architectures and applications
- Synthesis and optimization tools for FPGA's

Processor Design

- Register-transfer level ideas, abstractions, design style
- Stored program computers, data path, and control path partitions.
- Example processor designs: a simple instruction set
- General data path design techniques, example data path design
- General control path design techniques; hardwired control, microprogrammed control; example microprogrammed control path design

Assembly Language Programming

- Basics of storing, manipulating, moving data on a simulated processor
- Basics of control flow: straight-line code, conditional branches and loops
- Breaking programs into manageable pieces: subroutines, stack management, links to higher-level languages

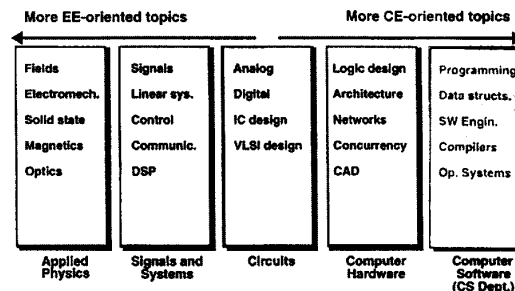

Fig. 4. ECE breadth areas.

G. ECE Breadth, Depth, Coverage, and Design Requirements

Before describing these requirements in detail, it is best to illustrate what "breadth" means in ECE by referring to the illustration in Fig. 4. Rather than simply partitioning the department into EE and CE halves, we chose instead to restructure it as a spectrum of five areas. Going to the left in the figure takes us more toward traditional EE topics; going to the right takes us toward traditional CE topics.

Courses from other departments appear at the far left and far right of the diagram, where our department has obvious interdisciplinary links to other departments at Carnegie Mellon, notably Physics and Computer Science. The idea is that these five areas have unique problems, methods, mathematics and modes of thinking. Courses allocated to an area share some of these attributes. By requiring students to take courses in three of these five areas, we enforce a consistent notion of breadth, without having to resort to requiring specific courses.

Specifically, to satisfy the ECE breadth requirement, students must take at least one first-level course in each of three of the five basic areas of ECE:

- *Applied Physics*: includes courses in electromagnetics, solid state devices, magnetics, data storage, and optics.
- *Signals and Systems*: includes courses in signals and systems fundamentals, as well as control, communication, signal processing, and robotics.
- *Circuits*: includes courses in both analog and digital electronics, as well as IC and VLSI design.
- *Computer Hardware*: includes courses in digital design, computer architecture, processor design, networks, real-time and multimedia systems, and CAD.
- *Computer Software*: includes programming, data structures, formal methods, software engineering, compilers, operating system, etc. (These courses are all offered by the School of Computer Science, with whom we maintain a reciprocal relationship: CS students take several hardware-oriented ECE classes, and ECE students can elect to take several software-oriented CS classes.)

Courses in these areas are referred to as *breadth* courses. Revisiting Fig. 4, we see this spectrum of five areas, with several representative types of courses listed in each area. Each area offers at least one, and possibly several introductory courses that can be taken starting with the three ECE fundamentals classes as prerequisites, along with perhaps some additional mathematics or science courses. More advanced courses in each area require some earlier area-specific ECE breadth courses as prerequisites.

A least three more courses must also be taken from the areas defined in the ECE breadth requirement; we refer to this as a “coverage” requirement. The idea here is to ensure that students see enough engineering courses to be called “engineers” when they graduate. Two additional requirements, the depth and design requirements, can be satisfied by dedicating two coverage courses to depth and design, respectively.

To satisfy the depth requirement, students must take at least one course that has as a prerequisite one of the courses used to meet the breadth requirement. Since most fundamental topics in our curriculum are covered in two-semester sequences, practically speaking, the depth requirement will cause students to complete at least once such sequence.

Carnegie Mellon has a long tradition of offering aggressive and challenging design courses. The design requirement is satisfied when a student completes one course from an approved list of design courses across ECE. These courses tend to be on the high end of our curriculum, and are generally quite popular. The intent is for students to take aim at these courses sometime during their Junior year, carefully picking up the required mathematics, science, and ECE prerequisites.

VI. IMPLEMENTATION AND ANALYSIS

Implementation of the new ECE curriculum began in the Fall semester of 1991. The first graduates of the curriculum appeared in the Spring of 1995. We discuss first some modifications related to actual implementation of the curriculum, as it evolved from 1991 to 1995. We next enumerate some example trajectories through the current curriculum, and then summarize our ongoing attempts to evaluate its impact. Finally, we describe a recent spin-off of the effort: A five-year combined ECE Master’s/Bachelor’s degree program.

A. Implementation

Several minor modifications have occurred to the “original” organization which was illustrated in Fig. 2. Some of these are simply the result of local idiosyncracies. Most notable among these is that not all courses at CMU have an identical number of credit units (notably mathematics, science, and humanities). Hence, many non-ECE courses do not completely “fill” one of the planned slots, making it difficult in a few places to obey the four-courses-per-semester guideline. One result of this was the inclusion of some extra mathematics requirements to partially fill this units gap. In addition, examination of ABET accreditation guidelines also contributed to these minor changes, resulting in a decision to increase somewhat the overall fraction of the program dedicated to technical subjects. As a result, 2.5 of the original free electives were transformed into:

- *Math/science electives*: Two courses must be selected in mathematics or the sciences—biology, chemistry, physics. These two courses occupy slots equivalent to 1.5 ECE engineering courses.
- *Probability and statistics*: We added this as a required mathematics course.

In addition, we added constraints to another free elective, requiring it to be technical, resulting in:

- *Engineering elective*: One course must be selected from across all engineering departments. This occupies one ECE slot.

As a practical matter, the resulting impact on flexibility was offset by changes in Carnegie Mellon’s humanities requirements (now referred to “general education” courses). Two of these eight general education courses (equivalent to 1.5 ECE engineering slots) can now be chosen freely from among nontechnical topics across CMU. Hence, constraining a few of our own free electives to be technical is

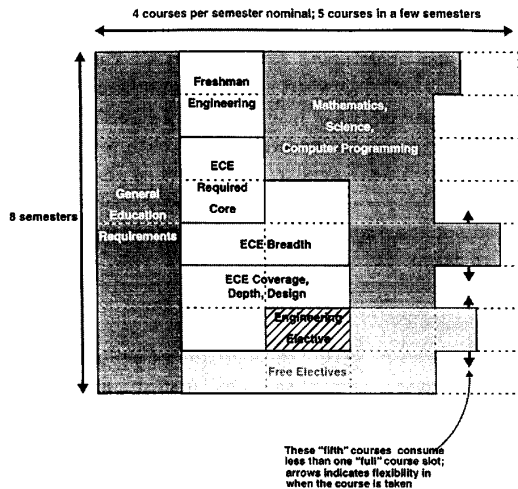

Fig. 5. New ECE curriculum: Basic organization in 1995.

essentially offset by these nontechnical free electives; this brings the curriculum back fairly close to its original form.

Updating the original form of the curriculum illustrated in Figs. 1 and 2, Figs. 5 and 6 illustrate more accurately the current, 1995 form of the ECE curriculum.

Nevertheless, many elements of the curriculum remain at odds with existing accreditation criteria: required courses remain few (note there is still no chemistry class), relatively free electives remain numerous, the EE and CE curricula remain integrated into a single BSCE degree. During the design of the original curriculum, ABET itself was a national focus of heated debate about the role of accreditation in fostering or stifling curriculum innovation. Indeed, the final report of an ABET task force on this issue [12] wrote in 1991 that:

... There has been a growing divergence of opinion between the engineering academic community, as represented by the Engineering Deans Council, and ABET, on matters critical to engineering education. This comes at a time when engineering education is facing significant challenges. In the future, engineering schools will have to attract and retain a more diverse student body with widely varying levels of preparation; engineering graduates will need a greater knowledge of foreign cultures and business practices as we compete in world markets; measures should be taken to alleviate the shortage of new, young American faculty in engineering schools; and engineering schools must take a role in reversing the current decreasing interest of high school students in engineering as a career. In order to deal with these problems, additional flexibility and innovation in engineering education are urgently needed.

During the last years, ABET has sought to improve the quality of engineering education, yet many of the engineering deans have expressed the opinion that ABET stifles innovation. Many in academia criticize the "bean counting" nature of an ABET evaluation and the uniformity of undergraduate engineering curricula, with ABET

criteria leaving little room for experimentation or new ideas.

However, the task force also concluded in [12] that "engineering schools should be encouraged and rewarded for experimentation and innovation in their programs, rather than be stifled and penalized for trying new ideas." ECE at Carnegie Mellon is pursuing accreditation as an experimental program under existing ABET guidelines for such experiments.

In early 1994 it was decided that, despite the small-scale modifications to the new curriculum proposal we actually implemented, ECE would apply for accreditation of the 1991 version of the new curriculum (see again Fig. 2) under the so-called ABET "innovative curriculum" clause that permits thoughtful experimental curricula that diverge from existing ABET standards to be considered on their merits. Our reasoning at the time was that, despite some small-scale changes to deal with local idiosyncracies such as the difference in units awarded in ECE classes versus non-ECE classes, the original, "pure" form of the curriculum was Carnegie Mellon's unique statement of how a curriculum ought to be organized. In September 1994 ECE was visited to start the accreditation process. Initial results of the visit were quite positive, comments from the review team were favorable and no deficiencies were found. We currently await ABET's final decision on accreditation.

A final implementation issue worth addressing is the role of faculty advising in a flexible curriculum. This remains a difficult problem, since we now explicitly expect students to make informed decisions early and throughout their education, decisions that will affect their elective choices, and hence their future careers. On the mechanical side, we have undertaken development of graphical, interactive curriculum planning software, available on campus workstations, that allows students to navigate through course syllabi, track their progress through our curriculum, and perform "what if?" analyses. For example, it is possible to query for which courses are required to reach any attractive Senior electives and design classes. Development of this software has proven to be a rather sizable undertaking, and continues as of this writing. On the qualitative side, the department has also recently reorganized its central advising office to add more semi-full-time technical staff, to ensure that there are always knowledgeable counselors available to handle student problems. In the reorganized plan, individual ECE faculty are still assigned undergraduate advisees, but the role of faculty has shifted to "technical counselor" responsible for helping students pick the right courses to satisfy their own technical interests and aspirations, rather than "curriculum auditor" responsible to ensure that the right number of course units are taken in the right areas. We continue to believe that advising is critical, but also that it remains difficult to do well.

B. Curriculum Templates: Example Paths Through the New ECE Curriculum

As a part of the curriculum design process, the Wipe-the-Slate-Clean Committee constructed example curricu-

FRESHMAN	FALL	General Education	Introduction to ECE	Computer Science Intro Programming	Calculus I	Computing Skills
	SPRING	General Education	Introduction to Eng	Physics I	Calculus II	
SOPHOMORE	FALL	General Education	Fundamentals of Electrical Eng	Physics II	Linear Algebra	
	SPRING	General Education	Fundamentals of Computer Eng	ECE Breadth 1	Discrete Math	
JUNIOR	FALL	General Education	ECE Breadth 2	ECE Breadth 3	Math/Science Elective	Probability / Statistics
	SPRING	General Education	ECE Coverage (Ex: Depth)	ECE Coverage	Math/Science Elective	
SENIOR	FALL	General Education	ECE Coverage (Ex: Design)	Engineering Elective	Free Elective	Free Elective
	SPRING	General Education	Free Elective	Free Elective	Free Elective	

Fig. 6. New ECE curriculum: Allocation of courses to areas in 1995.

FRESHMAN	FALL	General Education (9)	Introduction to ECE (12)	Computer Science Intro Programming (10)	Calculus I (10)	Computing Skills Workshop (3)
	SPRING	General Education (9)	Materials in Engineering (12)	Physics I (12)	Calculus II (10)	
SOPHOMORE	FALL	General Education (9)	Fundamentals of Electrical Eng (12)	Physics II (12)	Mathematical Foundations of EE (12)	
	SPRING	General Education (9)	Fundamentals of Computer Eng (12)	Engineering Electromagnetics I (12)	Modern Math (9)	Biology (9)
JUNIOR	FALL	General Education (9)	Digital Circuits (12)	Engineering Electromagnetics II (12)	Chemistry I (10)	
	SPRING	General Education (9)	Analog Circuits (12)	Semiconductor Devices I (12)	Signals and Systems (12)	C/Unix Skills (3)
SENIOR	FALL	General Education (9)	Analog IC Design (12)	Semiconductor Devices II (12)	Probability / Statistics (9)	
	SPRING	General Education (9)	Senior Project (12)	Fundamentals of Communication Systems (12)	Computer Control Systems Design Lab (12)	

Fig. 7. Curriculum template: A traditional electrical engineer (ECE-related classes appear in boldface, course units appear in parentheses).

lum templates, each illustrating—albeit only approximately. back in 1991—a different path to a four year Bachelor's degree in Electrical and Computer Engineering. We offer here a few of these templates, revised for our current 1995 curriculum implementation, to suggest ways in which the flexibility of the new curriculum can serve the needs of different students with different aspirations and preparation.

Perhaps the first observation to make is that a flexible curriculum in no way prevents a student from choosing a "traditional" sequence of courses. Hence, the course template in Fig. 7 shows how a conventional Electrical

Engineering program—conventional except, of course, for the existence of real engineering classes in the Freshman year—can be constructed within the constraints of the new ECE curriculum. This template shows the student pursuing the usual component of mathematics, physics, computer programming and ECE Fundamentals classes, as well as substantial breadth and depth in electromagnetics, circuits, signals and systems, and solid state. This curriculum culminates in a Senior year with a capstone design project in the area of controls, for example, as well as additional breadth classes in communications and solid state. By the standards

Best Copy Available

FRESHMAN	FALL	General Education (9)	Introduction to ECE (12)	Computer Science Intro Programming (10)	Calculus I (10)	Computing Skills Workshop (3)
	SPRING	General Education (9)	Fundamentals of Mechanical Eng (12)	Physics I (12)	Calculus II (10)	
SOPHOMORE	FALL	General Education (9)	Fundamentals of Computer Eng (12)	Physics II (12)	Modern Math (9)	
	SPRING	General Education (9)	Fundamentals of Electrical Eng (12)	Fundamentals of Computer Science I (12)	Linear Algebra (9)	C/Unix Skills (3)
JUNIOR	FALL	General Education (9)	Computer Architecture (12)	Fundamentals of Computer Science II (12)	Digital Circuits (12)	Probability / Statistics (9)
	SPRING	General Education (9)	Concurrency and Real-time Systems (12)	Intro to Computer-Aided Digital Design (12)	Numerical Methods (9)	
SENIOR	FALL	General Education (9)	Senior Project (6)	Advanced Digital Design Project (12)	Introduction to Telecommunication Networks (12)	
	SPRING	General Education (9)	Superscalar Processor Design (12)	Signals and Systems I (12)	Operating Systems (12)	Discrete Math (9)

Fig. 8. Curriculum templates: A traditional computer engineer (ECE-related classes appear in boldface, course units appear in parentheses).

of any traditional Electrical Engineering curriculum, this is a broad, solid plan of study.

A "traditional" Computer Engineering plan of study can also be within the framework of the proposed ECE curriculum, as shown in Fig. 8. Following the usual mathematics, physics, introductory programming, and ECE Fundamentals classes, the computer engineering student pursues a variety of computer hardware and computer software topics. Note that the breadth requirement that students elect one course in three of the five different ECE core areas does not permit a course of study so narrow that only hardware-related topics, or only software-related topics are selected to the exclusion of other areas of study. Moreover, the breadth requirement means that even after taking courses in the computer hardware and computer software areas, a third area must be selected for study. In the template shown in Fig. 8, the student attains this breadth in the circuits area, after having acquired the necessary preparation in the Fundamentals of EE class required of all ECE students. The Senior year culminates in a capstone design project in digital systems design, along with more depth in software and hardware, and additional breadth in signals and systems.

We have seen that the flexibility inherent in the proposed ECE curriculum does not preclude traditional avenues of study. Now let us consider instead new avenues of study that it creates. One possibility is illustrated by the course template shown in Fig. 9 which we call a "Preparatory Curriculum." Such a curriculum has exactly the same connotation that a traditional liberal arts curriculum usually carries: a broad, solid course of study emphasizing a variety of different areas that is worthy of a degree in itself,

but undertaken specifically as preparation for a subsequent professional degree. It has become increasingly obvious in recent years that not all students who pursue a Bachelor's degree in ECE actually remain Electrical or Computer Engineers for the rest of their lives. Moreover, we are seeing recently a few students who consciously choose an engineering degree as preparation for postgraduate study in other professional disciplines such as law, business, or medicine. We are specifically interested now in supporting an ECE degree as a general preprofessional degree—but without compromising the integrity of the ECE Bachelor's degree itself.

The plan of study shown here is one middle-ground approach. Observe that this student still takes the usual mathematics, physics, computer programming and ECE Fundamentals classes. In addition, the breadth, depth, ECE content and capstone design requirements are met, in this case with a combination of courses in signals and systems, circuits, computer hardware and computer software. Note that the emphasis in such a curriculum is breadth of experience, and exposure to many different technical topics. Nevertheless, the result is not a weak or simplified program, but rather, a program for what might be called the "ECE Core Generalist." Significant here is that the curriculum still leaves room for seven elective courses, in addition to Carnegie Mellon's already stronger-than-average requirement of eight humanities classes. With appropriate choices among these nontechnical classes, a very strong preparatory program can be created. In the example shown, we have populated the elective courses with economics, biology, and a foreign language. Of course, some of these elective

FRESHMAN	FALL	General Education (9)	Introduction to ECE (12)	Computer Science Intro Programming (10)	Calculus I (10)	Computing Skills Workshop (3)
	SPRING	General Education (9)	Introduction to Eng and Public Policy (12)	Physics I (12)	Calculus II (10)	
SOPHOMORE	FALL	General Education (9)	Fundamentals of Electrical Eng (12)	Physics II (12)	Linear Algebra (9)	Modern Chemistry I (10)
	SPRING	General Education (9)	Fundamentals of Computer Eng (12)	Modern Math (9)	Fundamentals of Computer Science I (12)	
JUNIOR	FALL	General Education (9)	Computer Architecture (12)	Digital Circuits (12)	Foreign Language I (9)	Probability / Statistics (9)
	SPRING	General Education (9)	Signals and Systems (12)	Analog Circuits (12)	Foreign Language II (9)	Biology I (9)
SENIOR	FALL	General Education (9)	Intro to Telecommunications Networks (12)	Economics I (9)	Foreign Language III (9)	
	SPRING	General Education (9)	Digital Communications and Signal Processing Design(12)	Economics II (9)	Foreign Language IV (9)	

Fig. 9. Curriculum template: An ECE core generalist (ECE-related classes appear in boldface, course units appear in parentheses).

choices could also be accomplished within the eight general education courses themselves; the point worth noting is that taken together, the humanities and elective slots provide considerable flexibility. With appropriate course choices, this course of study will produce students with a solid background in ECE core material, along with good preparation for further study in, for example, business or law.

This template shown in Fig. 10 is a more specific example of the Core-Generalist template presented in Fig. 9. The student in this program is specifically tailoring an ECE program toward a career in medicine. Notice, for example, the choice of the *Introduction to Chemical Engineering* class as a Freshman engineering elective (in addition to the *Introduction to ECE Freshman* course). This requires a chemistry class as a corequisite. In addition to the usual mathematics, physics, programming and ECE Fundamentals classes, this student pursues breadth in signals and systems, circuits, and computer software. Depth in signals and systems ultimately leads to a capstone design course in controls and instrumentation. Observe that it is possible to pursue a fairly traditional ECE core that also meshes nicely with the overall interest in medicine. In particular, using the elective slots, this student manages to take three biology classes and five chemistry or chemical engineering classes, to aid in preparation for medical school.

The flexibility in the new ECE curriculum allows an ECE Bachelor's program to be used as preparation for other postgraduate professional studies. However, the skeptical reader should not now jump to the conclusion that the new ECE curriculum is thus specifically tailored to those students who will not pursue engineering as their livelihood, to

the detriment of those who will actually become practicing Electrical and Computer Engineers. The critical attribute of a flexible curriculum is that it can adapt to a variety of students. Accordingly, we now consider yet another kind of curriculum: A "focused" program of study that emphasizes particular technical strengths at Carnegie Mellon.

Fig. 11 shows a template for a plan of study that focuses on data storage systems, with particular emphasis on magnetic recording media and the computer applications that use these media. The ECE department at Carnegie Mellon houses a National Science Foundation-supported Engineering Research Center called the Data Storage Systems Center. This center is the focus of interdisciplinary work on a variety of topics in data storage, from the material properties of magnetic media to the architecture of distributed file systems for computer networks. The template shown here is an example of how the new ECE curriculum can support interdisciplinary studies, surmounting some of the barriers between disciplines. The interesting feature of this course of study is its two seemingly disparate areas of concentration: magnetic media and computer systems. Normally, one just does not expect a student to take courses in, say, device physics and computer operating systems. And yet, engineers with precisely such an interdisciplinary background would be well positioned to understand and attack the interesting problems in data storage system design. This student achieves breadth in applied physics, circuits, computer hardware and computer software, as well as depth in relevant physics- and computer-related topics. The Senior year culminates in a capstone design project in data storage systems.

FRESHMAN	FALL	General Education (9)	Introduction to ECE (12)	Computer Science Intro Programming (10)	Calculus I (10)	Computing Skills Workshop (3)
	SPRING	Modern Chemistry I (10)	Introduction to Chemical Engineering (12)	Physics I (12)	Calculus II (10)	
SOPHOMORE	FALL	General Education (9)	Fundamentals of Electrical Eng (12)	Physics II (12)	Mathematical Foundations of EE (12)	Chemistry II (10)
	SPRING	General Education (9)	Fundamentals of Computer Eng (12)	Modern Math (9)	General Education (9)	Bio-Statistics (9)
JUNIOR	FALL	General Education (9)	Signals and Systems I (12)	Biology I (9)	Fundamentals of Computer Science I (12)	Organic Chemistry I (9)
	SPRING	General Education (9)	Digital Communications and Signal Processing Design (12)	Analog Circuits (12)	Bio-Chemistry I (9)	
SENIOR	FALL	General Education (9)	Fundamentals of Control (12)	Biology II (9)	Genetics (9)	
	SPRING	General Education (9)	Computer Control Systems Design Lab (12)	Engineering Electromagnetics I (12)	Organic Chemistry II (9)	

Fig. 10. Curriculum template: An ECE premed student (ECE-related classes appear in boldface, course units appear in parentheses).

FRESHMAN	FALL	General Education (9)	Introduction to ECE (12)	Computer Science Intro Programming (10)	Calculus I (10)	Computing Skills Workshop (3)
	SPRING	General Education (9)	Materials in Engineering (12)	Physics I (12)	Calculus II (10)	
SOPHOMORE	FALL	General Education (9)	Fundamentals of Electrical Eng (12)	Physics II (12)	Linear Algebra (9)	
	SPRING	General Education (9)	Fundamentals of Computer Eng (12)	Modern Math (9)	Calculus in 3-Dimensions (9)	Chemistry I (10)
JUNIOR	FALL	General Education (9)	Materials Science I (9)	Signals and Systems (12)	Fundamentals of Computer Science I (12)	Probability / Statistics (9)
	SPRING	General Education (9)	Engineering Electromagnetics I (12)	Introduction to Data Storage Systems (12)	Fundamentals of Computer Science II (12)	Fundamentals of Computer Science II (12)
SENIOR	FALL	General Education (9)	Engineering Electromagnetics II (12)	Data Storage Systems Lab (12)	Fundamentals of Controls (12)	
	SPRING	General Education (9)	Analog Circuits (12)	Materials Science II (9)	Computer Science Operating Systems (12)	

Fig. 11. Curriculum template: A data storage systems designer (ECE-related classes appear in boldface, course units appear in parentheses).

Best Copy Available

C. Analysis

To date, four cohorts of students have entered the new ECE curriculum, entering in the Fall of 1991, 1992, 1993,

and 1994, respectively. Each cohort had roughly 150 students. As of this writing, we still have incomplete data about graduates from the curriculum; the first graduates of the curriculum appeared concurrently with the preparation

of this paper. However, we have interesting data—anecdotal and quantitative—about the first three of these cohorts.

On the qualitative side, perhaps the most common observation is that the entering students are enthusiastic about starting real engineering classes in their first semester. They also simply appreciate the attention being paid to them by their actual chosen departments in their first year, as opposed to the older curriculum in which ECE played no role until late in the second year. There is also evidence that students are using the Freshman engineering courses offered by each department to help select their major, or at least, to decide which majors they do not wish to pursue. At least a few students have switched majors from their original choice after sampling the introductory Freshman course offered by that department. An unexpected positive side effect of teaching engineering early is that some students have actually been able to land engineering jobs during the summer after their Freshman year.

However, there were substantial adjustments necessary in faculty “teaching style” here, to accommodate very young students making a transition from high school courses with day-to-day, step-by-step guidance to college courses with more demands for individual initiative. One current solution is frequent small exams to test acquisition of the critical concepts.

The second year’s *Fundamentals of EE* and *Fundamentals of CE* classes also appear to be succeeding. The extra facility in the laboratory gained during the Freshman year helps considerably, allowing more interesting labs earlier in the curriculum. There is also evidence of students making active choices to select one or other of these courses early in the second year, to attain the prerequisites necessary to elect an ECE breadth course in the second half of the year. One common example is the election of *Fundamentals of EE* in the first half of the year, followed by *Signals and Systems* in the second half. Again, students especially like the idea of being able to elect real engineering classes early in the curriculum.

However, we still have concerns about the mathematical skills of the students by the end of their second year. The *Fundamentals of EE* class attempts to integrate the teaching of differential equations in the context of a linear circuits class, with a corequisite *Linear Algebra* class from the mathematics department. Four years into this curriculum, we think that our students still need more mathematics. In the Fall of 1995 a new ECE core class, called *Mathematical Foundations of Electrical Engineering* will be offered as an elective corequisite for the *Fundamentals of EE* class. This course will strive to fill the random gaps in crucial mathematical knowledge that even our best students exhibit, despite our best efforts to better integrate mathematics and engineering in the first two years. This new class will focus on complex analysis, ordinary differential equations, linear algebra and vector calculus, taught from a consistent EE perspective.

The top-to-bottom redesign of our individual courses, occasioned by the overall curriculum redesign, has also proved beneficial. An example helps make this concrete.

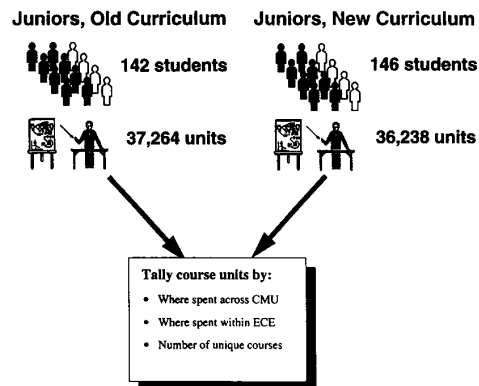

Fig. 12. Experiment to compare course elections between old and new ECE curricula.

In our current *Engineering Electromagnetics I* class, students create their own Matlab™ code and use existing software (some commercial finite element software and some educational software created by the instructor) to work on assignments that are relatively open-ended, with an orientation toward design as well as analysis. In the Fall of 1994, students in this course created their own software to map out the magnetic field structure in one wing of the building in which the Carnegie Mellon Computer Science, Mathematics, and Physics departments are housed. This wing of the building is situated directly above the 24 kV–4 kV main step-down transformers that supply power to the Carnegie Mellon campus. The magnetic field levels are high enough to cause significant interference with workstation monitors in this area, and some residents had also expressed concern about possible health effects. Starting from basic principles they had learned in the course and using tools they had created in one of the prior projects, students mapped out the field structure and compared their calculated results with measured results. This project worked well: it was interesting, challenging, relevant to a current engineering design problem, and reinforced basic ideas from the course. It also demonstrated clearly how even abstract, mathematically oriented engineering topics can benefit from creative laboratory assignments.

To answer questions about what students are actually doing with their newfound flexibility in this curriculum, we performed an experiment illustrated in Fig. 12. Two populations of students were identified for comparison:

- Students in the graduating class of 1992 who were Juniors during the 1990–1991 academic year, and whose previous three years of courses were taken in the *old* ECE curriculum.
- Students in the graduating class of 1995 who were Juniors during the 1993–1994 academic year, and whose previous three years of courses were taken in the *new* ECE curriculum.

We looked at all the courses elected over the preceding three years in each population of students, and counted where (department and college at Carnegie Mellon) each

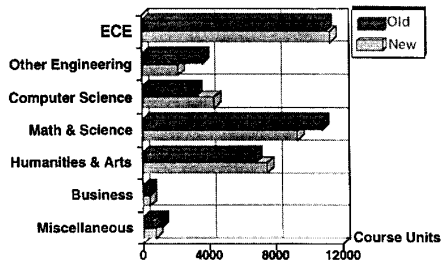

Fig. 13. Comparative course elections: Across Carnegie Mellon colleges.

course was taken, and for how many units of credit. At Carnegie Mellon, typical courses range from 9 to 12 units, the number representing the estimated hourly workload of the class. In the old curriculum, the typical workload was between 44 and 54 units per semester; in the new curriculum the target is for this to be 45 units per semester. The old curriculum required 388 units to complete the BS degree; the new curriculum requires 360, a reduction of essentially 2.5 classes. The data provide an interesting picture of how students are reacting to the new curriculum.

Fig. 13 tallies the number of units elected within ECE, and across the various colleges of Carnegie Mellon. One obvious fact is that, despite the flexibility to avoid some ECE courses, students are still spending most of their units inside ECE; there is no mass flight to easier courses. Election of courses in engineering outside ECE is down, primarily due to the elimination of old requirements to elect a few *ad hoc* courses in other engineering departments. The new curriculum allows all students to take two introductory courses in the Freshman year, one of which is usually in the student's major area—ECE for us. Election of computer science courses is up. There was always an unmet demand in the old curriculum by non-CE students to take more computer-related courses, but it was extremely difficult to fit them in. This appears to have been resolved in the new curriculum. Election of math/science classes is slightly down due to some changes in the required courses, for example, three nine-unit physics courses were replaced by two 12-unit courses, and the chemistry requirement was eliminated altogether.

There are also some interesting lower-level changes not apparent in this chart. For example, Fig. 14 shows the number of unique, i.e., *different* courses elected by the two populations. Students in the new curriculum are taking a wider variety of courses.

Fig. 15 refines the data related to ECE-specific courses in the top two bars of the chart of Fig. 13. Here, each course elected in ECE has been tallied based on the relevant ECE breadth area, as defined by the new curriculum. Courses in the old curriculum were matched to their best fit in the new curriculum. In addition, the Freshman *Introduction to Electrical and Computer Engineering* was arbitrarily counted as being half in the Computer Hardware area and half in the Circuits area. Fig. 15 shows where the 1994

Number of unique courses elected

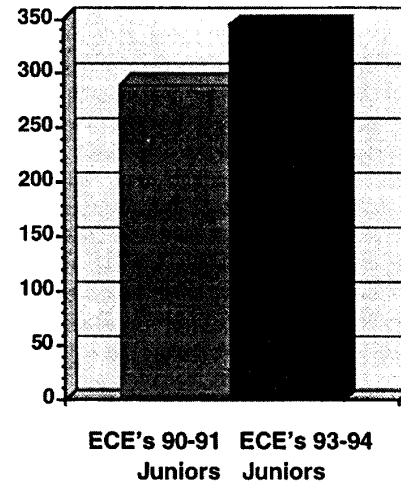

Fig. 14. Comparative course elections: Unique (different) courses.

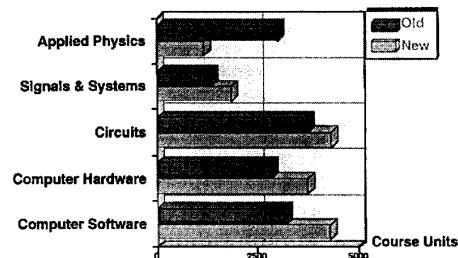

Fig. 15. Comparative course elections: Across ECE breadth areas.

Juniors chose to exercise their flexibility within the new curriculum, versus the mix of required and elective courses for 1991 Juniors in the old curriculum.

Again, there are several interesting observations. Election of Applied Physics courses is down substantially. In part this reflects the elimination of a solid state devices class required of all students (EE and CE) in the old curriculum, and of required electromagnetics courses for EE's. More interesting though is the choice of courses in the new curriculum. The elective solid state breadth course in this area has seen its enrollment increase nearly 50% in comparison with the old introductory solid state course. More students are now electing to sample the Applied Physics area via the solid state course, instead of via the electromagnetics course. Conversely, enrollment in electromagnetics courses has fallen by about 50%, though there is some evidence that the prerequisite of an extra calculus class (3-D methods) is making electromagnetics marginally less attractive. It has also been suggested that the lack of any recently offered design-oriented classes in this area that pull students towards electromagnetics is

also a contributing factor. New capstone design classes planned for this area (e.g., microwave design) might change this, as might the new *Mathematical Foundations of EE* course which will introduce 3-D vector calculus from an engineering perspective.

Election of Signals and Systems courses is up, primarily due to the popularity of the introductory breadth course in this area as a first ECE course beyond the *Fundamentals of Electrical Engineering* requirement. Circuits units are also up, due in some part to counting Freshman *Fundamentals of ECE* partly in this area, as well as *Fundamental of Electrical Engineering*, both of which are required. Computer hardware units are up, again for a similar reason due to *Fundamentals of ECE* and *Fundamentals of Computer Engineering*. Computer Software elections are also up strongly, reflecting continued interest in programming classes which now more easily fit into the schedules of ECE students who are not specifically trying to become computer engineers.

Overall, there is still substantial breadth of course elections among the ECE topical areas, and among Carnegie Mellon's colleges, albeit with some shifts in emphasis. None of the worst-case scenarios we might have imagined—mass flight from all difficult courses, for example—have come to pass. Most students continue to elect challenging courses, now somewhat more widely distributed across ECE's breadth.

Finally, Fig. 16 shows a preliminary analysis of where our first graduated cohort (129 students) are choosing to go for employment (as of graduation day, 1995). The integrated M.S./B.S. appears to be succeeding: the total number of students electing some form of graduate education is a record high for us. Technical employment opportunities remains strong, although financial institutions are now recruiting our engineering graduates more heavily. A significant fraction of the graduates are still undecided, e.g., among graduate schools, among job offers.

D. Integrated Five Year ECE Master's/Bachelor's Degree

One entirely unexpected recent spin-off of our curriculum design efforts is the recent creation of a five year integrated M.S./B.S. degree in ECE. There has been widespread discussion about how the best among our undergraduate students typically elect graduate school, but the solid middle-of-the-curve student typically enters industry immediately—despite the fact that another year of course and project work would be immensely helpful to that student's career. Similar to the model in place within Electrical Engineering and Computer Science at MIT [13]–[15], our program offers automatic admission to students who achieve a specified minimum grade point average over certain courses and ECE breadth areas.

The salient point here, however, was the unexpected ease of extending the undergraduate BSECE program to become an M.S./B.S. program. The undergraduate curriculum was simply extended as follows:

- *Breadth Requirement (One course)*: To increase the breadth in ECE, students must take one more course in

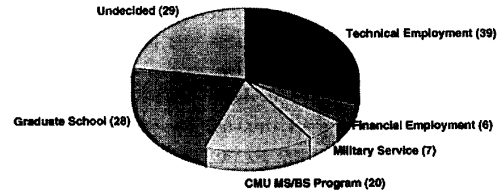

Fig. 16. Employment choices for first graduated cohort, class of 1995.

a “new” area—an area in which they have not already taken an introductory course (this makes four breadth areas rather than the three required for the Bachelor's degree).

- *Additional Design Capstone Requirement (One course)*: To further prepare students for engineering design work, they must take an additional course from the list of acceptable engineering design capstone courses (this makes two design capstone courses rather than the one required for the Bachelor's degree). Both design capstones can be in the same area or in different areas.
- *ECE Graduate Course Work (One course)*: Any senior-level or graduate or higher course(s) can be used to satisfy this requirement.
- *Advanced ECE Course Work (Three courses)*: Any graduate-level or higher or higher courses can be used to satisfy this requirement.
- *Advanced Engineering Course Work (Two courses)*: Any graduate-level advanced courses in ECE or any courses drawn from a list of designated non-ECE Advanced Engineering Course can be used to satisfy this requirement.

The new curriculum provided an exceptionally convenient base from which to evolve an integrated M.S./B.S. program. This program began in the Fall of 1994.

VII. CONCLUSION

In the Fall of 1991, after approximately two years of work, a novel Electrical and Computer Engineering curriculum was implemented at Carnegie Mellon. The curriculum features a small core of required classes, engineering courses beginning in the Freshman year, area requirements in place of specific course requirements, mandates on breadth, depth, coverage, and design, and an integrated Electrical and Computer Engineering Bachelor's degree. Four cohorts of students are in the pipeline of the new curriculum to date; the first class graduated in 1995. Measurements suggest that even with large amounts of flexibility, students continue to elect difficult, broad courses of study. We believe that flexibility in the election of courses, avoidance of rigid requirements and notions of exposure to all “critical” topics, and tolerance of students with widely varying preparation and aspirations are the essential features of the curriculum. In 1994 the curriculum was extended to incorporate an integrated five year Master's/Bachelor's ECE degree.

Rather than being a divisive exercise, we believe that our overall curriculum design process, including an analysis of the problems to address and the generation of some basic guiding principles to solve these problems, was a useful exercise in involving all our faculty in the evolution of the curriculum. Somewhat to our surprise, the curriculum and its design philosophy have been widely discussed outside of Carnegie Mellon [16]–[18]. Several hundred copies of the original curriculum design document [1] were requested from colleagues around the world. In this paper, we have tried to offer some additional insights on that design process, some analysis of its impact on our students, and some guidance to others undertaking this important task.

ACKNOWLEDGMENT

The new ECE curriculum was originally designed by the Wipe-the-Slate-Clean committee, whose membership included ECE faculty L. Richard Carley, Stephen W. Director, James F. Hoburg, Pradeep K. Khosla, B. V. K. Vijaya Kumar, Ronald A. Rohrer, Rob A. Rutenbar (Chair), T. Ehud Schlesinger, Daniel D. Stancil, Jay K. Strosnider, and Donald E. Thomas. Ronald P. Bianchini is the principal architect of the course planning software mentioned in the text. Much of the early implementation of the curriculum was overseen by James F. Hoburg and Daniel D. Stancil. Current implementation is being overseen by B. V. K. Vijaya Kumar. The authors are grateful to Kumar and Stancil for comments on earlier versions of the manuscript, and for the creation of many of the curriculum templates used in the text. The authors wish to dedicate this paper to the Carnegie Mellon ECE Class of 1995, the first class of students through our new curriculum, whose graduation happily coincided with the writing of this paper.

REFERENCES

- [1] R. A. Rutenbar *et al.*, "A new ECE curriculum for Carnegie Mellon," Tech. Rep., Dept. Elect. and Computer Engineering, Carnegie Mellon Univ., Sept. 1991.
- [2] B. V. K. Vijaya Kumar, R. A. Rutenbar, D. D. Stancil and R. M. White, Eds., "Electrical and computer engineering at Carnegie Mellon: A new curriculum," Tech. Rep., Dept. Elect. and Computer Engineering, Carnegie Mellon Univ., June 1995.
- [3] J. Gourand, "Electrical engineering, leading institutions—Rating of undergraduate program," in *The Gourand Report: A Rating of Undergraduate Programs in American & International Universities*, Nat. Educ. Standards, 1987.
- [4] W. F. Allman, "Special report: America's best graduate schools," *U.S. News & World Rep.*, pp. 78–83, Apr. 29, 1991.
- [5] EECS Committee on the First Professional Degree, "Revised proposals for new degree structures for EECS students," MIT Memo., Mar. 1991.
- [6] B. Goodman, "Toward a pump, not a filter," *Mosaic*, Nat. Science Found., vol. 22, no. 2, Summer 1991.
- [7] J. Hoburg, "Some thoughts on engineering education by a converted 'radical,'" *Focus*, Carnegie Mellon Univ., vol. 20, no. 1, Sept. 1990.
- [8] M. Van Valkenburg, "Changing curricular structure," *Eng. Educ.*, vol. 79, no. 4, May/June 1989.
- [9] M. G. Morgan, "Accreditation and diversity in engineering education," *Science*, vol. 249, no. 4972, Aug. 31, 1990.
- [10] R. A. Rohrer, "Taking circuits seriously," *IEEE Circ. and Devices*, vol. 6, no. 4, pp. 27–31, July 1990.
- [11] R. H. Katz, *Contemporary Logic Design*. Redwood City, CA: Benjamin/Cummins, 1994.

- [12] J. W. Prados *et al.*, "Final Report of the ABET/EDC Task Force," Mar. 1991; presented at the *Annu. Meet. Eng. Deans Council*, Alabama, Mar. 1991, and at the *ABET Board Meeting*, Chicago, IL, Apr. 1991.
- [13] P. Penfield Jr., J. V. Guttag, C. L. Searle, and W. M. Siebert, "Shifting the boundary: A professional master's program for 2000 and beyond," in *Proc. 1992 Frontiers in Educ. Conf.*, 1992, pp. 645–649.
- [14] ———, "Master of engineering: A new MIT degree," *Proc. 1993 ASEE Annu. Conf. Proc.*, 1993, pp. 58–61.
- [15] ———, "MIT EECS master of engineering: A status report," *Proc. 1994 Frontiers in Education Conf.*, Nov. 1994.
- [16] D. Christianson, "New curricula," *IEEE Spectrum*, vol. 25, July 1992.
- [17] G. F. Watson, "Refreshing curricula," *IEEE Spectrum*, vol. 29, pp. 33–35, Mar. 1992.
- [18] "Coming off the drawing board: Better engineers?" *Business Week*, Aug. 2, 1993.



Stephen W. Director (Fellow, IEEE) received the B.S. degree from the State University of New York at Stony Brook in 1965, and the M.S. and Ph.D. degrees in electrical engineering from the University of California at Berkeley, in 1967 and 1968, respectively.

From 1968 to 1977 he was with the Department of Electrical Engineering at the University of Florida, Gainesville. During 1974–1975 he was a Visiting Scientist in the Mathematical Sciences Department at IBM's T. J. Watson Research Center, Yorktown Heights, NY. He joined Carnegie Mellon University in 1977 and served as Head of the Department of Electrical and Computer Engineering from 1982 to 1991. In 1982 he founded the SRC-SMU Research Center for Computer-Aided Design and served as its Director from 1982 to 1989. He has served as President of the IEEE Circuits and Systems Society, as Chairman of the CAS Technical Committee of Computer-Aided Network Design (CANDE) and as Associate Editor of the IEEE TRANSACTIONS ON CIRCUITS AND SYSTEMS. He has authored or coauthored four texts.

Dr. Director received Best Paper Awards from the IEEE Circuits and Systems Society in 1975 and 1980, the Frederick Emmons Terman Award from the ASEE in 1976, and the W. R. G. Baker Prize Paper Award from the IEEE in 1978. In 1984 he received an IEEE Centennial Medal. He was elected to membership in the National Academy of Engineering in 1989. In 1992 he received the Society Award from the Circuits and Systems Society and a Best Paper Award from the ACM/IEEE Design Automation Conference.

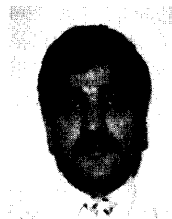

Pradeep K. Khosla (Fellow, IEEE) received the M.S. and Ph.D. degrees from Carnegie Mellon University.

He is a Professor of Electrical and Computer Engineering at Carnegie Mellon, and Director of the Advanced Manipulators Laboratory. He is currently on leave from CMU and serving as a Program Manager in the Software and Intelligent Systems Technology Office at ARPA, where he is responsible for programs in manufacturing and real-time software and planning. His present research interests are in real-time sensor-based manipulation, reusable software for real-time control and real-time operating systems, modular manipulators, integrated design-assembly systems, and robotic applications in space, field, and manufacturing environments.

Dr. Khosla is a member of The Robotics Institute.



Ronald A. Rohrer (Fellow, IEEE) received the B.S.E.E. degree from MIT in 1960, and the M.S.E.E. and Ph.D. degrees from the University of California at Berkeley in 1961 and 1963, respectively.

He is presently the Wilkoff University Professor of Electrical and Computer Engineering at Carnegie Mellon University. In addition to prior academic positions, he has been involved in a variety of R&D, marketing, and management positions in the electronic design automation industry. In 1964 he first published work on the computationally efficient use of gradient optimization in electronic circuit design. In 1969 he introduced a first-year graduate level project course that formed the basis for the industry standard SPICE circuit simulation program. In 1981 he was the founding editor of *IEEE TRANSACTIONS ON COMPUTER-AIDED DESIGN OF INTEGRATED CIRCUITS AND SYSTEMS* and was the 1987 president of the Circuits and Systems Society. His present research interests are circuit and mixed-signal simulation, extraction, and undergraduate electrical engineering education. He is the author or coauthor of three textbooks and several papers.

Dr. Rohrer has received the following awards: The National Electronic Conference (MIDCON) Best 1963 Research Paper Award; the 1964–1965 AFOSR NAS-NRC Postdoctoral Fellowship; the 1967 IEEE Browder J. Thomson Award; the 1970 IEEE Circuits and Systems Society Guillemin-Cauer Award; the 1972–1973 Alexander Von Humboldt Stiftung Senior Fellowship; the 1978 Frederick E. Terman Award for the ASEE; the 1990 IEEE Circuits and Systems Society Award; the 1990 Semiconductor Research Corporation Inventor Recognition Award for AWESim; the 1990 IEEE CAD Transactions Prize Paper Award; the 1991 ACM/IEEE Design Automation Conference Best Paper Award; the 1992 SRC Technical Excellence Award for Asymptotic Waveform Estimation (AWE); and the 1993 IEEE Education Medal. In 1989 he was elected to the US national Academy of Engineering for his contributions to simulation strategies for CAD for leadership in electrical engineering education.



Rob A. Rutenbar (Senior Member, IEEE) received the Ph.D. degree from the University of Michigan in 1984.

He joined the faculty of Carnegie Mellon University in 1984, where he is currently Professor of Electrical and Computer Engineering. Since 1993 he has been Director of the SRC-CMU Center for Excellence for CAD and IC's. He has worked extensively on algorithms for large electronic design automation problems. His research interests focus on circuit and layout

synthesis algorithms for mixed signal ASIC's, for high-speed digital systems, and for FPGA's.

Dr. Rutenbar received the following awards: a 1987 Presidential Young Investigator Award from the National Science Foundation; 1987 ACM/IEEE Design Automation Conference Best Paper Award; 1991 ACM IEEE International Conference on CAD Distinguished Paper Award; Semiconductor Research Corp TECHCON'93 Best Paper Award; 1989, Eta Kappa Nu Excellence in Teaching Award from Carnegie Mellon ECE; 1991 Teare Award for Excellence in Engineering Education from Carnegie Mellon's College of Engineering. He is currently on the Executive Committee of the IEEE International Conference on CAD, the Program Committees for the ACM/IEEE Design Automation Conference and European Design and Test Conference, and the Editorial Board of *IEEE Spectrum*. He chairs the Analog Technical Advisory Board for Cadence Design Systems.